



**DICKOW
PUMPEN**



**Heavy duty selfpriming
Side-Channel Pumps**

Type SC – PN40

General

The DICKOW-pump, type SC, is a selfpriming horizontal side-channel pump. The side-channel pump with its high differential head – also at low speed – has the advantage of operating more economical than normal centrifugal pumps for low capacities and high heads. Due to these facts, the side-channel pumps are appropriate to solve many pumping problems in chemical and petrochemical industries. The SC-pump is a heavy duty unit for handling clean liquids without solids. SC-pumps are also able to prime empty suction lines after initially filling with liquid before start-up. The maximum allowable operating temperature at standard design is 180°C (356°F). Special designs for higher temperatures on request.

Design

The SC-pumps are single or multistage side-channel pumps in heavy duty design with end suction and vertical discharge flanges. Flanges and casings are designed for a working pressure of 40 bar. Higher pressures on request.

Suction impeller / NPSH-values

To achieve low NPSH-conditions, a centrifugal impeller with enlarged eye area is located on suction side. The NPSH-values are based on water at 20°C (65°F). When handling boiling liquids, the required liquid level on suction side can be reduced to approximately 50% of these NPSH-values.

Side-channel impeller / start-up rings

The rotating star-shaped side-channel impellers are fitted in a chamber between the suction and pressure discs and keyed to the pump shaft in floating position as standard. No hydraulic thrust load exists.

To achieve selfpriming capability, best efficiency and rated differential pressure, tight clearances between the rotating impeller and the stationary discs are required.

During operation with properly filled pump, a stable fluid film between the impellers and the discs will center the impeller in the chamber and avoid metallic contact and seizing of the impeller between the discs. However, at dry running conditions and when handling volatile liquids with low viscosities, this fluid film will not be available or will not offer the required stability to avoid metallic contact and seizing of the impellers. To increase availability and to avoid seizing of the impellers in any case, the pumps can be fitted with additional SiC-rings as an option.

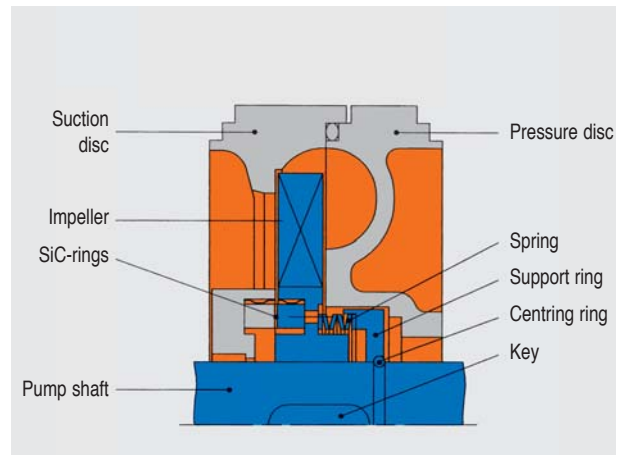

The SiC-rings are placed in the suction and pressure disc as well as in the impeller hub. The impeller ring will be pushed concentric to the ring in the disc by the spring and the support ring. Metallic contact between the rotating and stationary parts and seizing of the impeller are excluded.

Suction- and pressure discs

The suction- and pressure discs are sealed to the atmosphere by confined O-rings with metal to metal fit, to prevent blow outs. In the shaft area, floating graphite impregnated PTFE-inserts are located to reduce shaft deflection and wear. The differential head is built up in the side-channel of the pressure disc.

Pump shaft

The generous dimensioned pump shaft reduces deflection and ensures minimum torsional loads.

Ball bearings

The pump shaft is supported on discharge side by a generously dimensioned, grease lubricated ball bearing. Regreasing is possible by a grease nipple, fitted to the bearing cover.

The bearing is protected against product leakage and moisture by the deflector and the bearing cover.

Sleeve bearings on suction side

The pump shaft in the diffuser is supported by a sleeve bearing. Shaft sleeve and stationary radial bearing are made of wear resistant SiC.

Diffuser

The diffuser is designed as a retaining stage. That means the pump will still be filled with liquid after switch off and can be restarted without problem, also in selfpriming service with suction lift conditions.

Sectional drawing

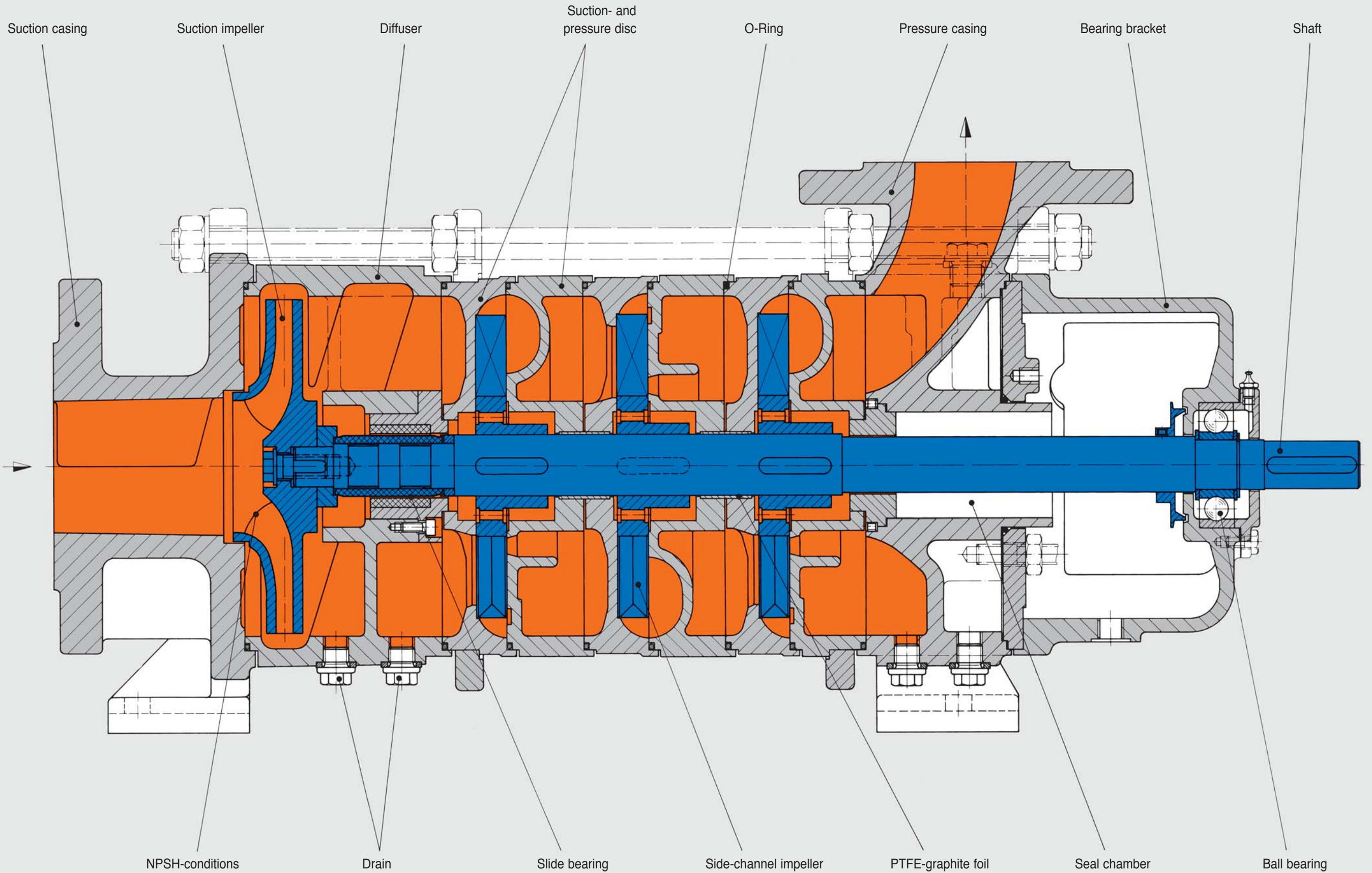

Available standard materials:

Bearing bracket	GG25	Suction impeller	GG25, 1.4408 (G-X5 CrNiMo 18.10)
Suction casing, diffuser, pressure casing	GGG40.3, 1.4408 (G-X5 CrNiMo 18.10)	Slide bearing, shaft sleeve	SiC-dry safe coating
Suction and pressure discs	GGG40.3, 1.4408 (G-X5 CrNiMo 18.10)	Shaft support	PTFE-graphite foil
Side-channel impeller	1.4457 (G-X25 CrNiMo 25.9)	Shaft	1.4021 (X20 Cr13), 1.4571 (X10 CrNiMoTi 18.10)

Dry running protection

Due to the tight clearances between the side-channel impellers and the stage disks, the standard design of these pumps will not tolerate any dry running. Liquid level monitoring in the suction line at flooded conditions is recommended. At selfpriming conditions with suction lift, an optoelectronic level detector can be fitted in the diffuser to monitor the required liquid level in the pump.

The design with additional SiC-rings can also accept dry running for limited time. Motor load monitoring can protect the pump at dry running condition.

Shaft sealing

The seal chambers of SC-pumps are designed to accept – besides gland packings – all common mechanical seal systems. Changing from gland packing to single or double acting seal is possible, also on site, without any remachining of the originally delivered pump parts. The diameter of mechanical seals comply with the preferential sizes 24, 28 and 33 mm according to DIN 24960.

Hazardous area

Together with the required Ex-drive motors, the SC-pumps can be applied in hazardous area Group II, Category 2. The pumps meet the basic safety and health requirements of Explosion-proof Directive 94/9 EC and Machinery Directive 98/37 EC and are suitable for plants with increased safety requirements.

For handling toxic, explosive or other dangerous liquids which react on contact with the atmosphere, the sealless magnetic coupled SCM-series are also available. More information about this design available on request. Some of the possible shaft sealing systems are displayed in the following sectional drawings.

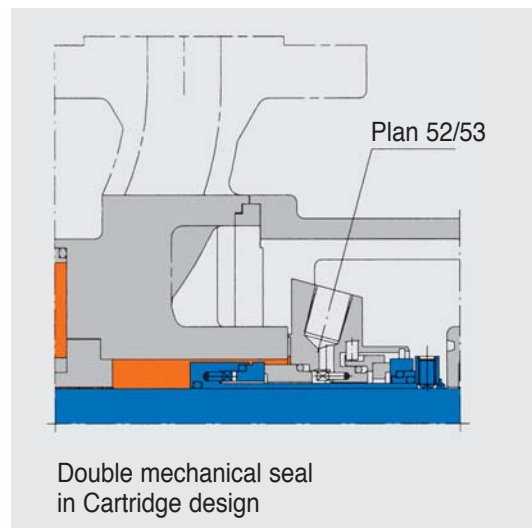
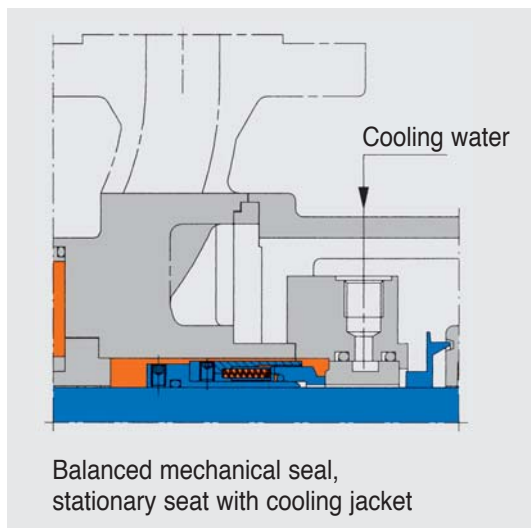
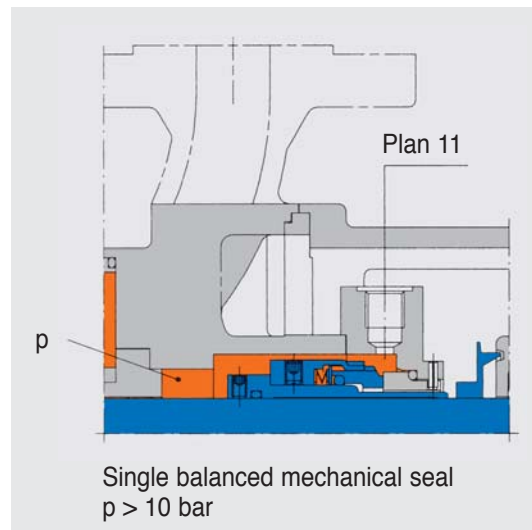
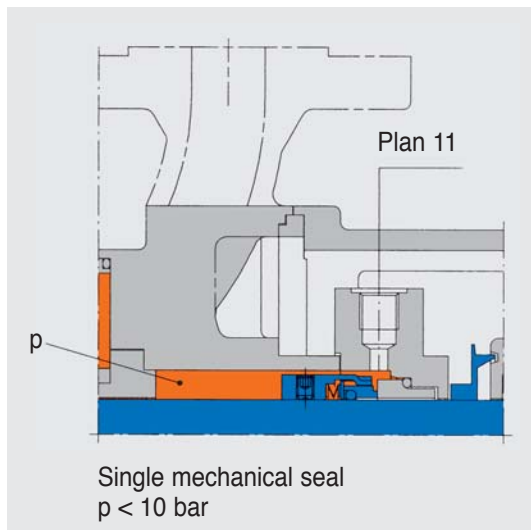

Performance range SC

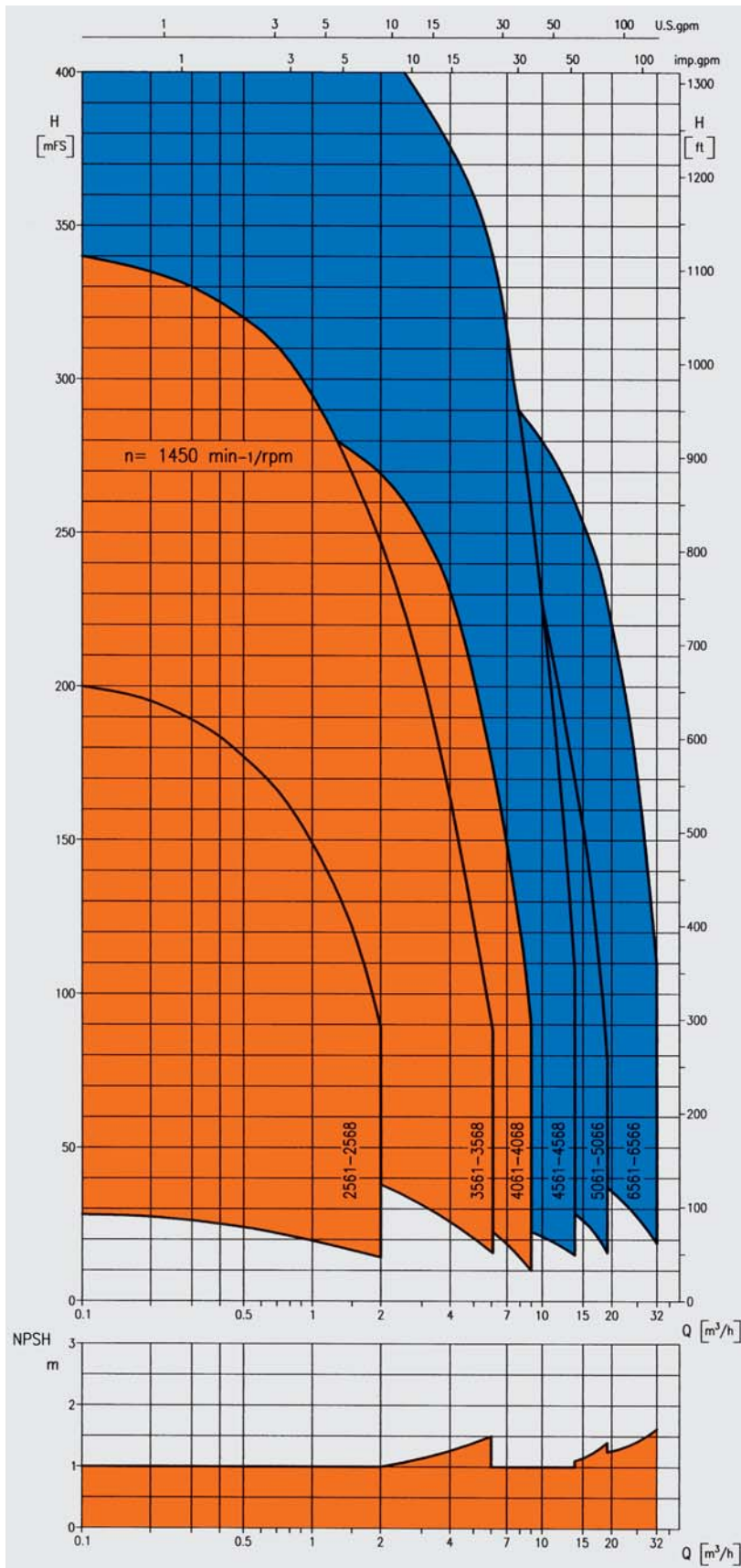

Performance curves of the individual pump sizes, also for 1750 rpm, with NPSH-values and power consumption are available on request.

